

# TAKSTAR® 得胜



**GX3** | **USB电容麦克风**  
USB Condenser Microphone

使用手册 | User Manual

中文目录.....	1-21
Table of Contents.....	22
前言.....	2
产品特性.....	2
产品配置.....	2
适用范围.....	2
系统要求.....	3
技术参数.....	3
综合参数.....	3
接口详情.....	3
功能示意.....	4
使用说明.....	5
一、设备安装及连接.....	5
二、电脑设置.....	8
三、手机设置.....	14
四、“得胜智+”软件下载及安装.....	15
安全警示.....	20
环保说明.....	20
关于图标含义解释.....	21
关于本说明书.....	21

### ■ 前言

尊敬的用户：

感谢您选购得胜GX3 USB电容麦克风,为了您能够更好地了解使用本产品,建议您在使用前仔细阅读本说明书。

若存在有疑问或者您有宝贵的建议,可通过拨打得胜官方服务热线400 6828 333或微信扫描二维码关注得胜官方公众号与我们联系。



### ■ 产品特性

- Type-C数字无损接口,即插即用,可兼容手机、平板及电脑使用;
- “得胜智+”软件,兼容手机端与电脑端,可进行更加专业的音频设置;
- 采用Φ14mm电容音头,灵敏度高,轻松捕捉细腻的声音细节;
- 内置DSP声卡芯片,专业混响效果,适用于直播、唱歌、录音等场景;
- 支持48kHz/16bit高采样率、录音采集、声音回放更清晰;
- 内置无线播放功能,无线材束缚,播放伴奏更自由;
- 无极复合旋钮,方便调节麦克风、耳机及混响音量;
- RGB炫酷灯效,多种灯光模式可切换,营造梦幻般的氛围;
- “得胜智+”软件内置几十种暖场特效,活跃直播间氛围;
- 附赠手机数据线,支持手机边充边用,直播续航无焦虑。

### ■ 产品配置

GX3 麦克风.....	1支
手机数据线 .....	1条
电脑数据线.....	1条
耳机.....	1条
支架转接头.....	1个
说明书.....	1份

### ■ 适用范围

适用直播、唱歌、录歌、游戏等场合

### ■ 系统要求

电脑:windows(win7或更高)

USB协议:USB2.0/USB3.0

MAC:macOS(10.10或更高)

手机:Android6.0以上,iOS9.0以上

### ■ 技术参数

#### 综合参数

- 数据传输:USB2.0
- 采样率:48kHz/16bit
- 音头:Φ14mm电容音头
- 指向性:心型
- 频率响应:20Hz-20kHz
- 峰值声压级:125dB (THD≤1% at 1kHz)
- 信噪比:67dB (A-Weighted)
- 话放增益:>35dB
- 耳机输出功率:80mW
- 耳机输出阻抗:32Ω
- 电源规格:5V=500mA
- 净重:约320g

#### 接口详情

- 耳机接口:Φ3.5mm
- 音频接口:Type-C

注:以上数据由得胜实验室测试得到,并拥有最终解释权!

■ 功能示意

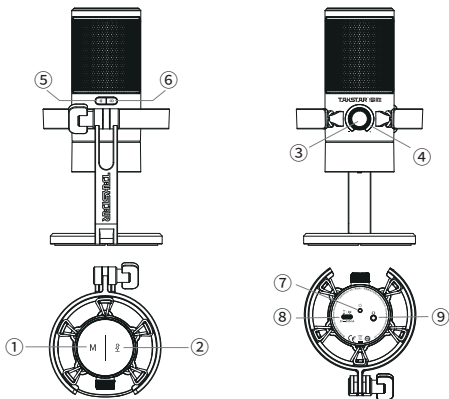

- ① 模式键：轻触切换“聊天模式”和“唱歌模式”，并伴随对应提示音；
- ② 静音键：轻触开启或取消麦克风静音；
- ③ 音量旋钮：点按循环切换、麦克风、耳机、混响控制通道，并有对应语音提示；旋转可调节对应的通道音量大小；
- ④ 音量指示灯：用于显示当前音量大小；音量每增加一级，亮度逐级递增，音量调到最小时指示灯全部熄灭；麦克风静音时，指示灯常亮红灯；
- ⑤ 蓝牙按键：点按开启或关闭蓝牙连接，长按清除配对，并有对应语音提示；
- ⑥ 内放按键：点按开启或关闭内放功能，并有对应语音提示，手机直播间与人连麦PK时，关闭内放功能；
- ⑦ 灯光按键：点按切换白、粉、橙、黄、绿、浅蓝、深蓝、紫、多彩9种灯光效果，长按开启/关闭灯光效果；
- ⑧ Type-C接口：连接手机、平板、电脑等智能终端设备，可自动识别麦克风驱动，兼容Windows、Mac、iOS、Android系统；
- ⑨ 3.5mm耳机接口：Φ3.5mm立体声耳机接口，接入耳机设备进行声音实时监听。

### ■ 使用说明

由于说明书篇幅局限,不能详述本产品的所有功能,如需了解本产品更加详细的安装操作说明,可按照以下方式查产品使用教程,打开手机微信扫描以下“得胜智+”小程序二维码或扫描包装上的“得胜智+”小程序二维码,点击进入“得胜智+”微信小程序主界面;在“主界面”版块里面点击的“功能介绍”页面进行了解,也可以通过登陆得胜官网(<https://www.takstar.com/>)进入到该产品详情页了解更多产品相关信息。



“得胜智+”小程序

#### 一、设备安装及连接

##### 手机端连接

##### 1. 单手机连接方法

使用配送的“手机数据线”与用于直播或录制歌曲的手机进行连接,将数据线插头上标有“接话筒”字样的一端与麦克风底部的Type-C接口连接,再将标有“□”图标的一端与苹果或安卓手机连接,将“手机数据线”插头上标有“接充电”字样的一端与适配器或者移动电源连接,支持手机直播时边充电边用。

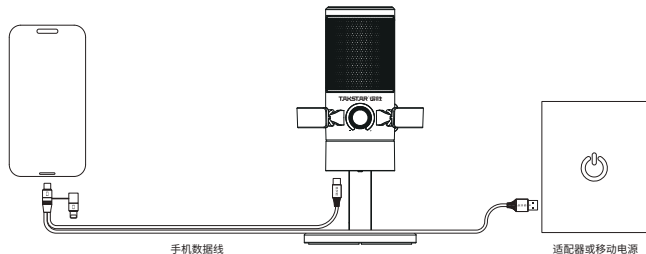

安卓及苹果15以上手机连接方法

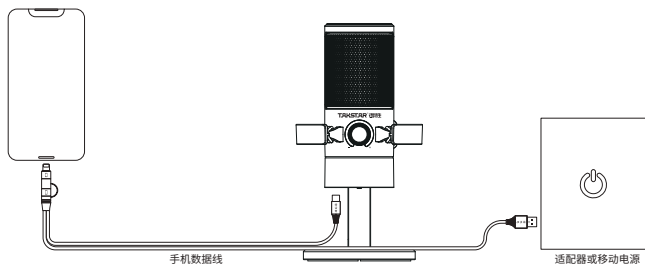

苹果15以下手机连接方法

### 2. 双手机连接方法

按单手机连接方法将用于直播或录制歌曲的手机连接好,然后点按麦克风背面的蓝牙按钮,开启蓝牙连接功能。拿出另一台手机作为播放伴奏的手机,打开该手机的“设置”菜单,找到蓝牙连接列表,搜索“TAKSTAR GX3 Audio”并点击连接,连接成功后即可实现一部手机用来直播,一部手机用来播放伴奏了。

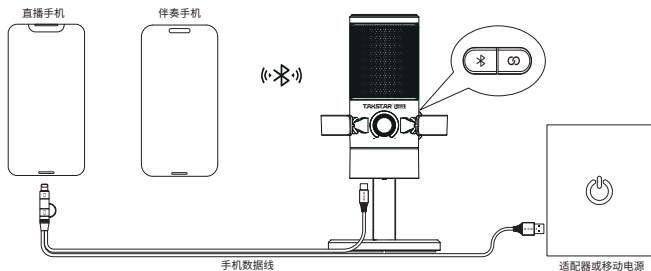

### 电脑端连接

#### 1. 电脑连接方法

使用配送的“电脑数据线”一端与麦克风底部的Type-C接口连接，另一端与电脑的USB端口连接。

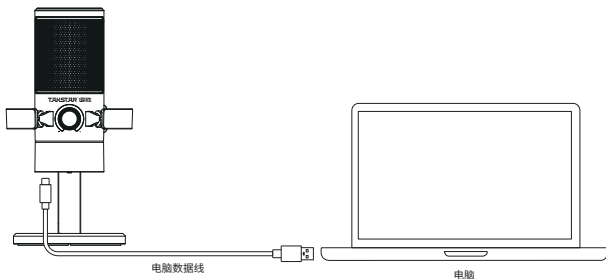

#### 2. 电脑+手机连接方法

按电脑连接方法将用电脑连接好，然后点按麦克风背面的蓝牙按钮，开启蓝牙连接功能。拿出另一台手机作为播放伴奏的手机，打开该手机的“设置”菜单，找到蓝牙连接列表，搜索“TAKSTAR GX3 Audio”并点击连接，连接成功后即可实现电脑用来直播，手机用来播放伴奏了。

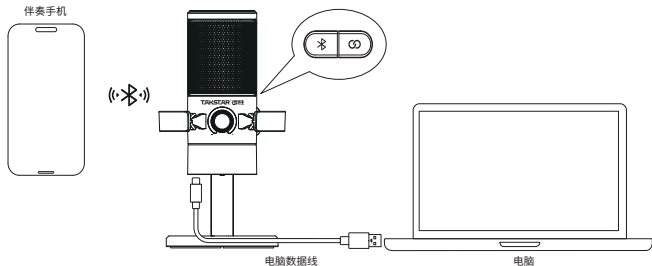

### 麦克风正确使用方式

麦克风带有旋钮的一面为正面,使用时请确保麦克风的正面对准声源,人与麦克风建议保持15-30厘米的拾音距离。

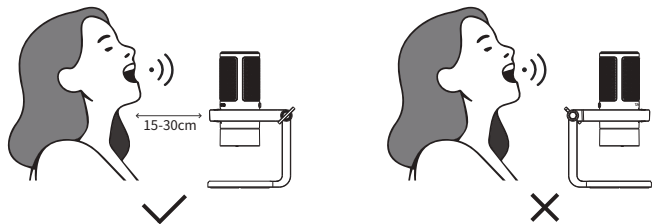

## 二、电脑设置

在电脑上使用GX3 USB麦克风时,需将音频选项设置为“TAKSTAR GX3”,以Windows10和MAC OS系统为例,其他版本的系统操作方法相似,此处不再赘述。

### Windows10系统设置

1. 鼠标右键单击右下角的扬声器图标,选择“打开声音设置”;

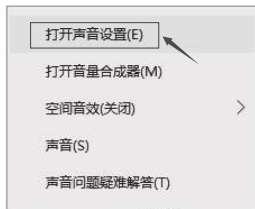

2. 选择“声音控制面板”，进入“声音”设置对话框；



3. 在“声音”对话框中选择“录制”选项，将“TAKSTAR GX3”设置为默认设备。当使用麦克风说话时，对话框中的麦克风的音量指示图标会变成绿色并跳动；



4. 双击“TAKSTAR GX3”进入麦克风属性，选择“级别”选项，将麦克风音量调整为100%，如图所示：



5. 在麦克风属性对话框中选择“侦听”选项，查看“侦听此设备”是否为勾选状态，如果是的话，请取消勾选；



6. 在“声音”对话框中选择“播放”选项，将“TAKSTAR GX3”设置为默认设备，如图所示：



7. 双击“TAKSTAR GX3”进入耳机属性，选择“级别”选项，将耳机音量调整为适当的音量，建议调整到100%的音量，该音量调整的是电脑播放的音量，具体可根据个人对声音大小的接受程度进行调整，如图所示：



### MAC OS系统设置

1. 双击打开“系统偏好设置”，选择“声音”，打开“声音”对话框，如下图所示；



2. 单击“输入”选项,选择“TAKSTAR GX3”作为声音输入设备,拖动“输入音量”至100%状态;



3. 在“输出”选项中,选择“TAKSTAR GX3”作为声音输出设备,将“输出音量”调整为适当的音量,建议调整到100%的音量,该音量调整的是电脑播放的音量,具体可根据个人对声音大小的接受程度进行调整,如下图所示:



### 三、手机设置

#### iOS系统设置

1. 通过配送的“手机数据线”连接手机，具体详见说明书的“手机端连接”部分；
2. 从右上角边缘向下轻扫，打开控制中心，点击右上角播放控制面板内“📶”、“🎧”、“🔊”图标进入设备列表窗口；
3. 在出现的窗口中查看设备是否显示为“TAKSTAR GX3”，如是，说明麦克风与手机连接成功。如图所示：



#### Android系统设置

麦克风兼容大部分带OTG功能的智能安卓手机，可能有部分型号手机和应用软件会限制OTG功能，这并不是麦克风质量原因导致的，请您与您的移动设备供应商确认您的手机是否支持OTG功能。如OPPO、vivo品牌的部分手机需要打开OTG功能才能正常使用。

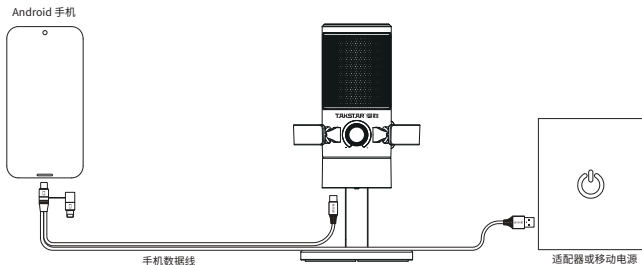



### 四、“得胜智+”软件下载及安装

#### 电脑端软件下载及安装

“得胜智+”适用于Windows7或更高版本，MacOS系统暂不支持，软件也会不断升级适配MacOS系统。

为保障良好的用户体验，我们会持续不断的更新软件功能，本说明书描述的软件功能只适用于产品发布时的版本状态，如果您下载安装了更新的版本或进行了版本升级操作，软件功能以及操作界面有可能会发生变化，以最新升级的操作界面为准。

下载方法：请访问(<https://www.takstar.com/>)，进入得胜官网，服务支持页面找到下载中心，在搜索框输入“GX3”进行搜索，找到“得胜智+”软件安装包进行下载。

安装方法：将下载好的文件进行解压缩，得到图标所示的软件安装程序，双击图标进入安装界面，点击“下一步”完成安装。

#### 电脑端软件功能说明

麦克风连接电脑后，双击电脑桌面的图标启动“得胜智+”软件，进入到软件主界面，点击主界面的麦克风产品图，进入到软件的操作界面，对麦克风进行专业的音频设置。操作界面包含模式区、输入区、输出区、功能区、特效区。





### 1. 模式区

预设聊天、唱歌、主持、游戏、喊麦5种模式，点击可切换不同模式，内置对应场景预设效果；

### 2. 输入区

- 话筒音量：向左调节减小话筒音量，向右调节增大话筒音量；
- 蓝牙伴奏：向左调节减小蓝牙伴奏音量，向右调节增大蓝牙伴奏音量；
- 混响大小：向左调节减小混响量，向右调节增大混响量（仅在唱歌、喊麦模式下可以调节混响大小）；
- 降噪强度：向左调节减小降噪强度，向右调节增大降噪强度，可根据周围环境的嘈杂程度进行选择；
- 变声效果：开启后呈现类似女变男、男变女的音效，等级越高，听起来的音效强度越大（只有游戏模式下支持变声功能）。

### 3. 输出区

- 耳机音量：向左调节减小耳机音量，向右调节增大耳机音量；
- 直播音量：向左调节减小直播音量，向右调节增大直播音量。

### 4. 功能区

- 闪避：开启闪避，说话时背景音乐会自动压低音量，关闭则恢复到正常状态；



- RGB灯光: 点击  展开设置界面, 可进行RGB灯光开关控制、灯光亮度调节、9种灯光颜色选择以及2种灯光模式切换, 有常亮模式 (选定颜色持续常亮)、呼吸模式 (模拟呼吸节奏渐变明暗)
- 蓝牙: 点击打开或关闭蓝牙连接功能, 快速控制与外部蓝牙设备的连接状态;
- 耳返: 开启或关闭麦克风的实时返听功能。开启时耳机里可实时监听麦克风声音, 关闭后, 耳机里不能实时监听麦克风的声音, 无论是开启或关闭耳返功能, 都不影响麦克风声音传输给网络对方 (唱歌、喊麦模式下默认开启耳返功能, 无法关闭);
- 内放: 在电脑端使用时, 如需要通过录音软件可以同时录制到人声和电脑播放的伴奏音乐, 要打开内放, 适合电脑制作翻唱歌曲的情况; 在手机端使用时, 如需要通过手机端的录歌软件或录歌功能录制歌曲时, 要关闭内放, 录制后通过录歌软件进行翻唱歌曲的合成; 当需要在电脑端或手机端的直播间与人连麦PK时, 要关闭内放功能;

### 5. 特效区

- 点击  展开特效界面, 内置30种特效音 (掌声、哄笑、欢呼等) 选择, 点击开始播放特效。在播放特效过程中, 如果再次点击该特效音, 将立即停止播放。

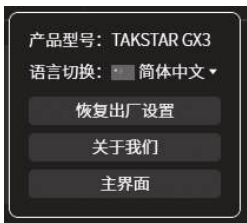
### 6. 语言切换、恢复出厂设置、关于我们以及主界面



- 语言切换: 点击 , 在“语言切换”下拉选项中选择所需语言, 共有简体中文、繁体中文、English三种语言切换。
- 恢复出厂设置: 点击“恢复出厂设置”选项, 可以将麦克风所有设置恢复至原始出厂状态。
- 关于我们: 点击“关于我们”选项, 可查看版本信息及软件更新, 若有新版本可按指引进行在线升级;
- 主界面: 点击“主界面”选项, 返回软件主界面, 在此界面下, 点击右上角的  可以检查软件更新版本, 点击麦克风产品图可进入到软件的操作界面。

### 进入手机端微信小程序方法

1. 首先按照本说明书“手机端连接方法”将麦克风与直播手机连接好，为了使用“得胜智+”小程序的时候不会终止直播，建议用播放伴奏的手机来使用小程序，不要用直播的手机来使用小程序（即一部手机用于直播，另一部手机用于播放伴奏及使用小程序）；
2. 拿出用于播放伴奏的手机，打开手机微信扫描以下“得胜智+”小程序二维码或扫描包装上的“得胜智+”小程序二维码，点击进入“得胜智+”微信小程序主界面；



“得胜智+”小程序

3. 点击“搜索新设备+”按钮，小程序开始进行搜索，当找到“TAKSTAR GX3”设备后，点击进入小程序操作界面；
4. 点击“功能介绍”按钮进入到“得胜学堂”，了解产品更多使用帮助。



### 手机端微信小程序功能说明

“得胜智+”小程序操作界面主要分为“调音台”、“特效”、“灯光”、“我的”四大功能区，功能与电脑端软件基本相同，此处不再赘述。



## ■ 安全警示

为避免电击、高温、着火、辐射、爆炸、机械危险以及使用不当等可能造成的人身伤害或财产损失,使用本产品前,请仔细阅读并遵守以下事项:

1. 使用产品时请确认所连设备与本产品是否匹配以及合理调整音量大小,不要在超过产品功率及大音量下长时间使用,以免造成产品异常和听力损伤;
2. 使用中若发现有异常(如冒烟、异味等),请立即关闭电源开关并拔掉电源插头,然后将产品送售后服务网点检修;
3. 消费者若使用电源适配器供电,则应购买配套使用获得CCC认证并满足标准要求的电源适配器;
4. 本产品及配件都应放置在室内干燥通风处,请勿长期存放在潮湿、灰尘多的环境,使用中避免靠近火源、雨淋、进水、过度碰撞、抛掷、振动本机及覆盖通风孔,以免损坏其功能;
5. 若产品需要固定于墙壁或天花板时,请确保固定到位,防止因固定强度不足导致产品发生跌落危险;
6. 使用该产品时需遵守相关安全规定,法律法规明确禁止使用场合请勿使用本产品,以免导致意外事故;
7. 请不要自行拆机改装或维修,以防止出现人身伤害,如有问题或服务需求请联系当地售后服务网点跟进处理。

## ■ 环保说明

产品中有毒有害物质或元素的名称及含量标识表

部件名称	有毒有害物质或元素									
	铅 (Pb)	汞 (Hg)	镉 (Cd)	六价铬 (Cr(VI))	多溴联苯 (PBB)	多溴二苯醚 (PBDE)	邻苯二甲酸 二正丁酯 (DBP)	邻苯二甲酸 二异丁酯 (DIBP)	邻苯二甲酸 丁基酯 (BBP)	邻苯二甲酸 二(2-乙基)己酯 (DEHP)
塑料部件	○	○	○	○	○	○	○	○	○	○
金属部件	×	○	○	○	○	○	○	○	○	○
电路板组件	×	○	○	○	○	○	○	○	○	○
线缆	×	○	○	○	○	○	○	○	○	○

本表格依据SJ/T 11364的规定编制。

○: 表示该有害物质在该部件所有均质材料中的含量均在GB/T 26572规定的限量要求以下。

×: 表示该有害物质至少在该部件的某一均质材料中的含量超出GB/T 26572规定的限量要求。

此标志为产品的环保使用期限标志,

且此环保使用期限只适用于产品正常工作的温度和湿度等条件。



### ■ 关于图标含义解释



根据RL2004/108/EG和European Low Voltage Directive (欧洲低电压指令)

RL2006/95/EG的测试结果表明,本产品符合欧共体关于电磁兼容性的成员国法律整合的指令中所规定的限值。



此符号表示,根据WEEE指令(2012/19/EU)和国家法律,由于这种类型的废弃物会有潜在的有害物质,可能对环境和人类健康产生负面影响,所以本产品不应与您的家庭垃圾一起处置,应将本产品交由授权的电气和电子设备(WEEE)回收站回收。同时,您在正确处理本产品的同时将有助于自然资源的有效利用。如需了解更多有关您可以在何处放置废物回收设备的信息,请联系您当地的城市办事处、废物管理局或家庭废物处理服务部门。

### ■ 关于本说明书

本说明书中内容符合截止印刷之日的技术规格。由于得胜公司会不断改进产品,本说明书可能不符合您的特定产品的技术规格。要获取最新版说明书,请访问得胜官网,然后下载说明书文件。技术规格、设备或另售的附件在各个地区可能有所不同,如有问题请与当地得胜销售网点确认。如需更多支持和深层产品信息,请浏览得胜官方网站:  
<https://www.takstar.com>

版权所有 ©2025 得胜。得胜、TAKSTAR及其各自标志是得胜公司在中国和/或其他国家/地区的注册商标或商标。所有其它商标均是各自所有者的财产。

Preface.....	23
Features.....	23
Package Contents.....	24
Applications.....	24
System Requirements.....	24
Specifications.....	24
Overall Specifications.....	24
Interface Details.....	24
Function Descriptions.....	25
Operating Instructions.....	26
I. Device Installation and Connection.....	27
II. Computer Settings.....	30
III. Mobile Phone Settings.....	35
IV. Download and Installation of "Takstar Smart+" Software.....	36
Safety Instructions.....	41
Label Meanings.....	42
About This Manual.....	42

### ■ Preface

Dear Customer,

Thank you for purchasing Takstar GX3 USB Condenser Microphone. In order to better understand and use the product, please read this manual carefully. If you have any questions or suggestions, please contact our local dealer.

### ■ Features

- Type-C uncompressed digital interface with plug-and-play operation, compatible with smartphones, tablets and computers.
- "Takstar Smart+" software, compatible with both mobile and computer terminals, enabling more professional audio settings.
- Equipped with a  $\Phi$ 14mm condenser capsule, featuring high sensitivity for easily capturing delicate sound details.
- Built-in DSP sound card chip with professional reverb effects, suitable for scenarios such as live streaming, singing, and recording.
- Supports 48kHz/16bit high sampling rate, resulting in clearer audio recording and playback.
- Built-in wireless playback function, free from cable constraints, providing more freedom for playing accompaniment.
- All-in-one endless encoder knob for convenient adjustment of microphone, headphone and reverb volume.
- RGB cool lighting effects with multiple switchable light modes, creating a dreamlike atmosphere.
- "Takstar Smart+" software comes with built-in dozens of warm-up effects, enlivening the live broadcast room atmosphere.
- Includes a mobile phone data cable, supporting simultaneous charging and use of the phone, eliminating worries about battery life during live streaming.

### ■ Package Contents

1 × GX3 Microphone	1 × Phone Data Cable	1 × Computer Data Cable
1 × Headphones	1 × Stand Adapter	1 × User Manual

### ■ Applications

Suitable for live streaming, singing, song recording, gaming

### ■ System Requirements

Computer: windows (win 7 or later)

USB protocol: USB2.0/USB3.0

MAC: macOS (10.10 or later)

Phone: Android 6.0 or later, iOS 9.0 or later

### ■ Specifications

#### Overall Specifications

- Data Transmission: USB 2.0
- Sampling Rate: 48kHz/16bit
- Capsule:  $\Phi$ 14mm condenser capsule
- Polar Pattern: Cardioid
- Frequency Response: 20Hz-20kHz
- Max SPL: 125dB (THD $\leq$ 1% at 1kHz)
- Signal-to-Noise Ratio: 67dB (A-Weighted)
- Microphone Gain: >35dB
- Headphone Output Power: 80mW
- Headphone Output Impedance: 32 $\Omega$
- Power Supply: 5V=500mA
- Net Weight: Approx. 320g

#### Interface Details

- Headphone Jack:  $\Phi$ 3.5mm
- Audio Interface: Type-C

Note: The above data are measured by Takstar laboratory which has the final interpretation right!

## ■ Function Descriptions

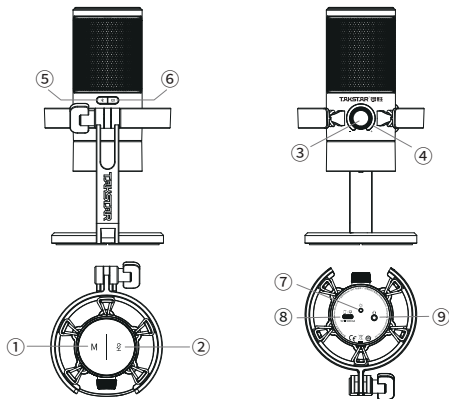

- ① Mode Button: Tap to switch between "Chat Mode" and "Karaoke Mode" with corresponding prompt tones.
- ② Mute Button: Tap to enable or disable microphone mute.
- ③ Volume Knob: Tap to cycle through microphone, headphone, and reverb control channels, with corresponding voice prompts; rotate to adjust the volume of the corresponding channel.
- ④ Volume Indicator Light: Used to display the current volume level; the brightness increases incrementally with each volume level up, and all indicators turn off when the volume is set to the minimum; when the microphone is muted, the indicator stays red.
- ⑤ Bluetooth Button: Tap to enable or disable Bluetooth connection; long press to clear pairing, with corresponding voice prompts.
- ⑥ Loopback Button: Tap to enable or disable the loopback function, with corresponding voice prompts. Disable the loopback function when in a mobile live stream PK.

- ⑦ Light Button: Tap to switch between 9 lighting effects (dark blue, green, light blue, yellow, orange, pink, purple, white, and multi-color); long press to turn the lighting effect on/off.
- ⑧ Type-C Interface: Connect to smart terminal devices such as mobile phones, tablets, and computers; automatically recognizes the microphone driver and is compatible with Windows, Mac, iOS, and Android systems.
- ⑨ 3.5mm Headphone Jack:  $\Phi$ 3.5mm stereo headphone jack; connect headphone devices for real-time sound monitoring.

### ■ Operating Instructions

Due to space limitations in the manual, not all functions of this product can be detailed. If you need to access more comprehensive installation and operation instructions for this product, you can check the product tutorial in the following ways: Open WeChat on your mobile phone to scan either the following "Takstar Smart +" WeChat Mini Program QR code or the one on the package, then click to enter the main interface of the "Takstar Smart +" WeChat Mini Program. You can learn more by clicking on the "Function Introduction" page in the "Main Interface" section. Alternatively, you can log in to Takstar's official website (<https://www.takstar.com/>) and navigate to the product details page to obtain more product-related information.



"Takstar Smart +" Mini Program

### I. Device Installation and Connection

#### Mobile Phone Connection

##### 1. Single Mobile Phone Connection Method

Use the included "mobile phone data cable" to connect to the mobile phone used for live streaming or song recording. Connect the end of the data cable plug marked "Connect to Microphone" to the Type-C interface at the bottom of the microphone, then connect the end marked with the "☐" icon to an iPhone or Android phone. Connect the end of the "mobile phone data cable" plug marked "Connect to Charger" to a power adapter or power bank, supporting simultaneous charging and use during mobile phone live streaming.

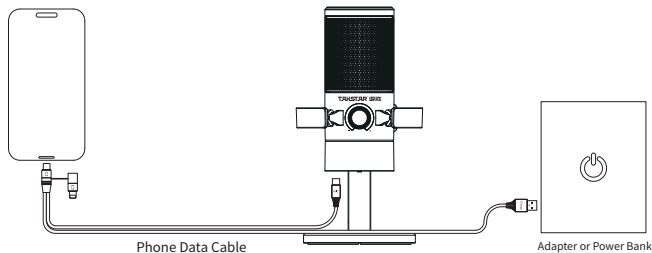

Connection methods for Android and iPhone 15 and above

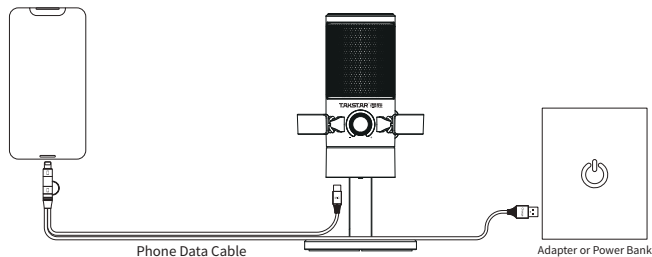

Connection methods for iPhone below 15

### 2. Dual Mobile Phones Connection Method

Connect the mobile phone used for live streaming or song recording according to the single mobile phone connection method. Then tap the Bluetooth button on the back of the microphone to enable the Bluetooth connection function. Take out another mobile phone as the one for playing accompaniment, open the "Settings" menu of this phone, find the Bluetooth connection list, search for "TAKSTAR GX3 Audio" and tap to connect. After successful connection, one phone can be used for live streaming and the other for playing accompaniment.

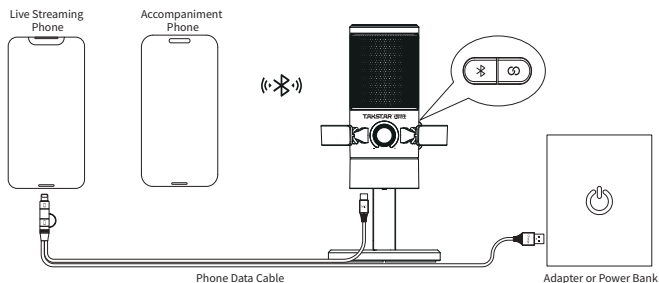

### Computer Connection

#### 1. Computer Connection Method

Use the included "computer data cable"—connect one end to the Type-C interface at the bottom of the microphone, and the other end to the USB port of the computer.

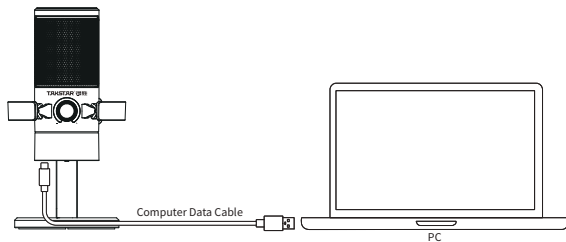

### 2. Computer + Mobile Phone Connection Method

First, connect the computer according to the computer connection method. Then tap the Bluetooth button on the back of the microphone to enable the Bluetooth connection function. Take out another mobile phone as the one for playing accompaniment, open the "Settings" menu of this phone, find the Bluetooth connection list, search for "TAKSTAR GX3 Audio" and tap to connect. After successful connection, the computer can be used for live streaming and the mobile phone for playing accompaniment.

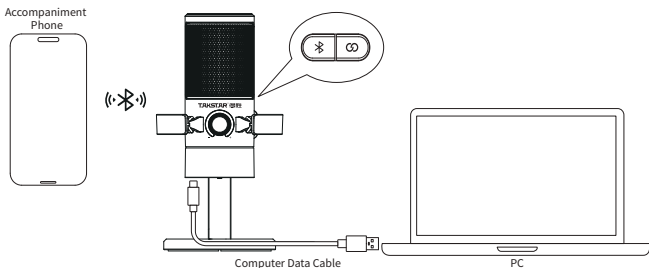

### Correct Usage of the Microphone

The side of the microphone with the knob is the front side. When in use, ensure the front side of the microphone is aligned with the sound source. It is recommended to maintain a sound pickup distance of 15-30 cm between the user and the microphone.

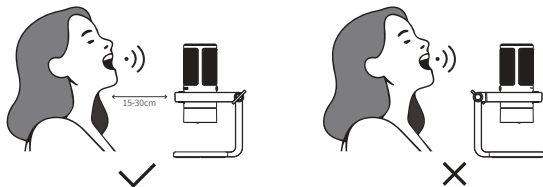

### II. Computer Settings

When using the GX3 USB microphone on a computer, you need to set the audio option to "TAKSTAR GX3". Taking Windows 10 and MAC OS systems as examples, the operation methods for other versions of systems are similar and will not be repeated here.

#### Windows 10 System Settings

1. Right-click the speaker icon in the bottom right corner and select "Open Sound settings".

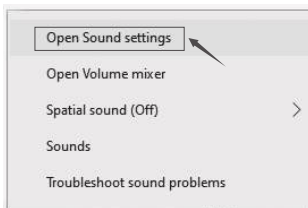

2. Select "Sound Control Panel" to access the "Sound" settings dialog box.

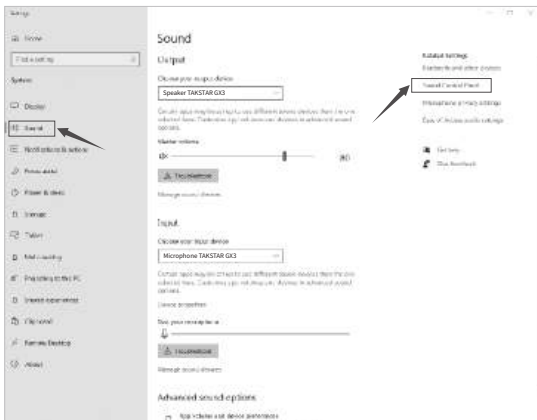

3. In the "Sound" dialog box, select the "Recording" tab, and set "TAKSTAR GX3" as the default device. When speaking into the microphone, the microphone's volume indicator icon in the dialog box will turn green and pulse.

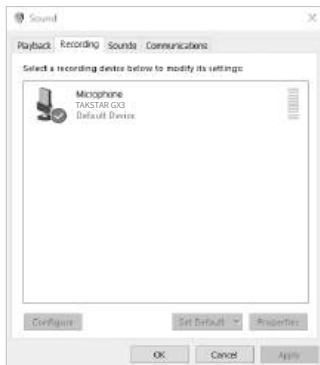

4. Double-click "TAKSTAR GX3" to enter Microphone Properties, select the "Levels" tab, and adjust the microphone volume to 100%, as shown in the diagram:



5. In the Microphone Properties dialog box, select the "Listen" tab, check if "Listen to this device" is checked. If so, please uncheck it.



6. In the "Sound" dialog box, select the "Playback" tab, and set "TAKSTAR GX3" as the default device, as shown in the diagram:



7. Double-click "TAKSTAR GX3" to enter Headphone Properties, select the "Levels" tab, and adjust the headphone volume to 100%. It is recommended to set it to 100%. This adjustment controls the volume of the computer's playback, and can be modified according to personal preference for sound volume, as shown in the diagram:



### MAC OS System Settings

1. Double-click to open "System Preferences", select "Sound" to open the "Sound" dialog box, as shown in the diagram below:





2. Click the "Input" tab, select "TAKSTAR GX3" as the sound input device, and drag the "Input volume" to 100%.

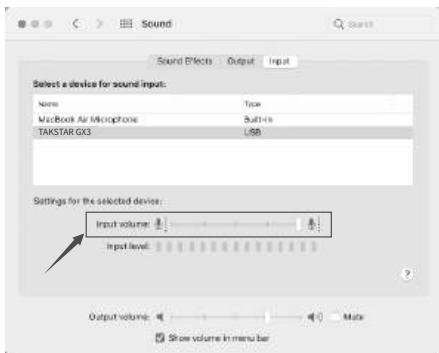

3. In the "Output" tab, select "TAKSTAR GX3" as the sound output device, and adjust the "Output volume" to an appropriate level. It is recommended to set it to 100%. This adjustment controls the volume of the computer's playback, and can be modified according to personal preference for sound volume, as shown in the diagram below:

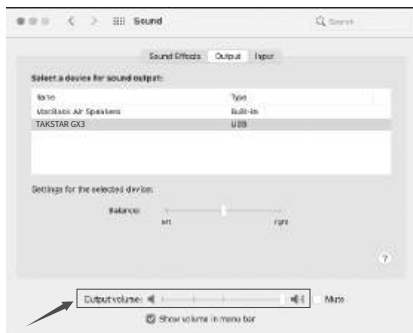

### III. Mobile Phone Settings

#### iOS System Settings

1. Connect the mobile phone using the included "mobile phone data cable"; for details, refer to the "Mobile Phone Connection" section in the manual.
2. Swipe down from the top-right edge to open the Control Center, then tap the "📶", "🎧", "🔊" icons within the playback control panel at the top-right corner to access the device list window.
3. In the displayed window, check if the device is shown as "TAKSTAR GX3". If yes, it indicates that the microphone is successfully connected to the mobile phone. As shown in the diagram:

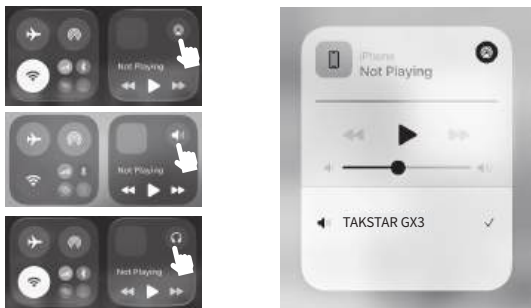

### Android System Settings

The microphone is compatible with most smart Android phones with OTG function. Some phone models and applications may restrict the OTG function, which is not caused by the microphone's quality. Please confirm with your mobile device supplier whether your phone supports the OTG function. For example, some phones of OPPO and vivo brands need to enable the OTG function to work properly.

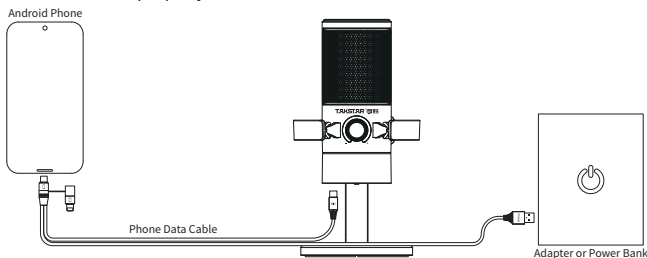

### IV. Download and Installation of "Takstar Smart+" Software Software Download and Installation for Computer

"Takstar Smart +" is compatible with Windows 7 or later versions; MacOS is not currently supported, but the software will continue to be upgraded to adapt to MacOS.

To ensure a good user experience, we will continuously update the software functions. The software functions described in this manual only apply to the version at the time of product release. If you download and install an updated version or perform a version upgrade, the software functions and operation interface may change, and the latest upgraded operation interface shall prevail. Download Method: Please visit (<https://www.takstar.com/>), go to the official Takstar website, find the Download Center on the Service & Support page, enter "GX3" in the search box to search, and then find the "Takstar Smart +" software installation package to download.

Installation Method: Unzip the downloaded file to get the software installer as shown by the icon "📄". Double-click the icon "📄" to enter the installation interface, and click "Next" to complete the installation.

### Software Function Description for Computer

After the microphone is connected to the computer, double-click the icon "📄" on the computer desktop to start the "Takstar Smart+" software, enter the software's main interface, click the microphone product image on the main interface to enter the software's operation interface, and perform professional audio settings for the microphone. The operation interface includes Mode Section, Input Section, Output Section, Function Section and Special Effects Section.





### 1. Mode Section

5 preset modes are available: Chat, Karaoke, Host, Game, and MC. Click to switch between modes, each with built-in preset effects tailored to the corresponding scenario.

### 2. Input Section

- Microphone Volume: Adjust left to decrease volume; adjust right to increase volume.
- Bluetooth Accompaniment Volume: Adjust left to decrease volume; adjust right to increase volume.
- Reverb Level: Adjust left to reduce reverb; adjust right to enhance reverb (Reverb effect is only activatable in Karaoke and MC modes).
- Noise Reduction Intensity: Adjust left to weaken noise reduction; adjust right to strengthen noise reduction. Adjust based on ambient noise levels.
- Voice Changing Effect: When enabled, it produces effects like female-to-male or male-to-female voice transformation. The higher the gain level, the greater the audio intensity (Voice changing is only supported in Game mode).

### 3. Output Section

- Headphone Volume: Adjust left to decrease volume; adjust right to increase volume.

- **Live Streaming Volume:** Adjust left to decrease volume; adjust right to increase volume.

#### 4. Function Section



- **Ducking:** When enabled, background music will be automatically turned down while speaking; when disabled, it will return to normal volume.
- **RGB Lights:** Click  to expand the settings interface, which allows control of RGB lighting on/off, adjustment of light brightness, selection of 9 lighting colors, and switching between 2 lighting modes: Steady Mode (selected color stays on continuously), Breathing Mode (gradually fades in and out to simulate breathing rhythm).
- **Bluetooth:** Click to turn on or off the Bluetooth connection function, quickly controlling the connection status with external Bluetooth devices.
- **Monitor:** Turns on or off the microphone's real-time monitor function. When enabled, the microphone sound can be monitored in real-time through the headphones; when disabled, real-time monitoring of the microphone sound through the headphones is unavailable. Whether monitor is on or off, it does not affect the transmission of microphone sound to the other party over the network (Monitor is enabled by default in Karaoke and MC modes and cannot be disabled).
- **Loopback:** For computer use, enable loopback if you need recording software to capture both your voice and the computer's background music (suitable for making cover songs on PC). For mobile use, disable loopback when recording songs via a song recording app/function, then mix the cover using the app. Disable loopback when doing live PK with others on a computer or mobile live rooms.

#### 5. Special Effects Section

Click  to expand the sound effects interface, which includes 30 built-in sound effects (such as applause, crowd laughter, cheers, etc.) to choose from. Click to start playing the effect. During the playback of an effect, clicking the same sound effect again will stop the playback immediately.

### 6. Language Switching, Factory Reset, About Us and Main Interface



- **Language Switching:** Click  to select the desired language from the "Language Switching" dropdown menu. There are three languages available: Simplified Chinese, Traditional Chinese, and English.
- **Factory Reset:** Click on the "Factory Reset" option to restore all microphone settings to their original factory state.
- **About Us:** Click the "About Us" option to view version information and software updates. If there is a new version, you can perform an online update by following the instructions.
- **Main Interface:** Click on the "Main Interface" option to return to the main software interface. On this interface, click the icon  in the upper right corner to check for software update versions, and click the microphone product image to enter the software's operation interface.

### ■ Safety Instructions

To avoid electric shock, overheat, fire, radiation, explosion, mechanical risk and injury or property loss due to improper use, please read and observe the following items before use:

1. Please check if the power of the connected equipment matches with that of this product before operation. Adjust the volume to proper level during operation. Do not operate at over-power or high-volume level for extended time to avoid product malfunction and hearing impairment.
2. If there is any abnormality during use (e.g., smoke, strange odor), please kill the power switch and unplug from power source, then send the product to the local after-sales service for repair.
3. Consumers should purchase a matching power adapter that has obtained CCC certification and meets the required standards when using a power adapter for power supply.
4. Keep this product and its accessories in a dry and ventilated area. Do not store in a humid or dusty area for extended time. Keep away from fire, rain, liquid intrusion, bumping, throwing, vibrating, or from blocking any ventilation openings, to prevent malfunction.
5. The product must, when installed on walls or ceilings, be fixed firmly in place at adequate strength to prevent from falling.
6. Please abide by safety rules during operation. Do not use the product in places prohibited by laws or regulations to avoid accident.
7. Do not disassemble or repair the product unauthorized to avoid injury. If you have any questions or require any services, please contact our local after-sales service.

### ■ Label Meanings

 This device is compliant with the limits of the European Council Directive on the approximation of the laws of the member states relating to electromagnetic compatibility according to RL2004/108/EG and European Low Voltage Directive RL2006/95/EG.

 This symbol indicates that this product should not be disposed of with your household waste, according to the WEEE directive (2012/19/EU) and your national law. This product should be handed over to an authorized collection site for recycling waste electrical and electronic equipment (WEEE). Improper handling of this type of waste could have a possible negative impact on the environment and human health due to potentially hazardous substances that are generally associated with WEEE. At the same time, your cooperation in the correct disposal of this product will contribute to the effective usage of natural resources. For more information about where you can drop off your waste equipment for recycling, please contact your local city office, waste authority, or your household waste disposal service.

### ■ About This Manual

This manual contains up-to-date technical specifications as of printing. However, specifications contained herein may not conform to your particular product since Takstar is constantly improving its products. Also, specifications, devices or accessories available may vary from region to region. If you have any questions, please contact our local sales outlet. For the latest version/more information, please visit our website: <https://www.takstar.com/>

Copyright ©2025 TAKSTAR. TAKSTAR, 得胜 and their respective logos are registered trademarks or trademarks of Takstar company in the PRC, and/or other countries. All other trademarks are the property of their respective owners.

## 注意事项:

1. 本单为保修凭证, 请用户妥善保管, 如有遗失, 恕不保修或退换。
2. 保修期限制: 购买之日起2年内。
3. 除了不可抗力事件损坏外, 由本公司负责, 免费维修。
4. 如属保管不善或使用不当造成的损坏, 维修点将酌情收费。
5. 擅自拆卸维修者, 不予保修。
6. 以上保修条款仅限于中国市场适用 (不含港澳台地区)。

## 产品服务保证书

姓名: \_\_\_\_\_ 电话: \_\_\_\_\_ 地址: \_\_\_\_\_

商品: \_\_\_\_\_ 型号: \_\_\_\_\_ 购买日期: \_\_\_\_\_ 年 \_\_ 月 \_\_ 日

维修记录栏 (由维修员填写)	维修员签名	日期

◆ 广东得胜电子有限公司 ◆ 电话: 400-6828-333 ◆ 地址: 广东省惠州市博罗县龙溪街道富康一路2号



扫一扫，了解更多产品  
Scan for more  
product information



“得胜智+”小程序  
"Takstar Smart+"  
Mini Program

## 广东省电声工程技术研究开发中心 广东得胜电子有限公司制造

地址：广东省惠州市博罗县龙溪街道富康一路2号

服务热线：400 6828 333 传真：0752-6383950

邮箱：xs@takstar.com

网址：www.takstar.com

Guangdong Takstar Electronic Co., Ltd.

Address: No. 2 Fu Kang Yi Rd., Longxi Boluo

Huizhou, Guangdong 516121 China

Tel: 86 752 6383644 Fax: 86 752 6383952

Email: sales@takstar.com

Website: www.takstar.com